

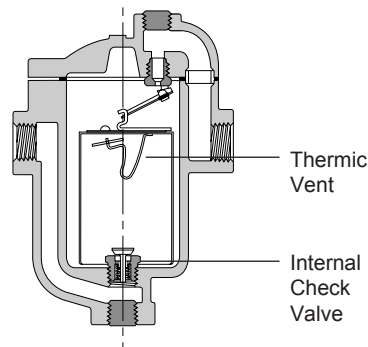

Armstrong® Steam Trap Options

Thermic Vent Buckets

Whenever steam is turned on and off, air will accumulate in the piping and steam equipment. A trap equipped with a thermic bucket will discharge this air 50 to 100 times faster than a standard bucket, reducing warm-up time. Thermic vent buckets are suitable for pressures up to 130 psig (9 barg). A large vent hole in the bucket can also solve air venting problems upon start-up.



Internal Check Valves—1/2" (15 mm) Thru 2" (50 mm) NPT

Almost all Armstrong inverted bucket steam traps can be equipped with internal check valves. A check valve is needed between the trap and the equipment being drained in the following cases:

- When the trap is installed above the unit drained
- When sudden pressure drops may occur in the steam supply to the unit
- Whenever a back pressure exists in the condensate return line

Armstrong spring-loaded, stainless-steel internal check valves can be screwed directly into the trap inlet or into an extended inlet tube having a pipe coupling at the top.

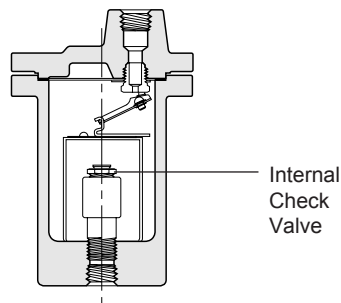

"In-Line" Check Valve—1/2" (15 mm) and 3/4" (20 mm) NPT

On 1800 and 2000 Series stainless-steel traps, an internal check valve cannot be installed. Armstrong's CVI "in-line" check valve will solve the problem.

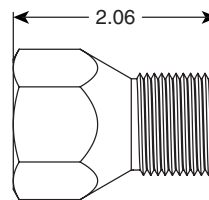

Pop Drain for Freeze Protection

In general, a properly selected and installed Armstrong trap will not freeze as long as steam is coming to the trap. If the steam supply is shut off, a pop drain should be used to automatically drain the trap.

Maximum Operating Conditions

Pressure: 600 psig (41 barg)
Temperature: 350°F (177°C)

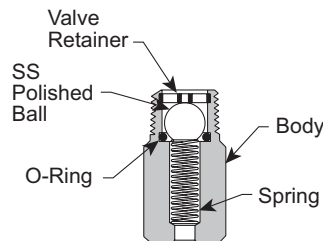

Steam Trap Options

Vacuum Breaker—3/8" (10 mm) and 1/2" (15 mm) NPT

Many times, condensate will be retained ahead of steam traps because of the presence of a vacuum. To break a vacuum, air must be introduced into the system by means of a vacuum breaker.

For maximum protection against freezing and water hammer in heating coils under modulated control, for example, vacuum breakers are recommended in conjunction with freeze protection devices.

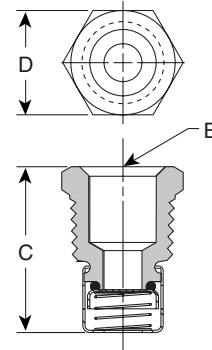

| Vacuum Breaker | | | | |
|----------------------|---------|--------|-----------|--------|
| Size | in | mm | in | mm |
| | 1/2 NPT | 15 | 3/8 NPT | 10 |
| "B" Pipe Connections | 3/8 NPT | 10 | 1/4 NPT | 6 |
| "C" Height | 1-1/4 | 32 | 1-3/32 | 28 |
| "D" Width | 7/8 Hex | 22 Hex | 11/16 Hex | 17 Hex |

Dirt Problems

Whenever dirt plugs the bucket vent, Armstrong recommends the use of a scrubbing wire which, on each cycle, keeps the bucket vent hole open.

NOTE: On small size stainless-steel (only) bucket traps, a wiggle wire is installed as standard.

In normal conditions, the inverted bucket trap is not sensitive to dirt problems (because of its orifice at the top of the trap), unlike most other traps, which should be installed normally with a strainer (see Armstrong "Y" Type Strainers page 445).

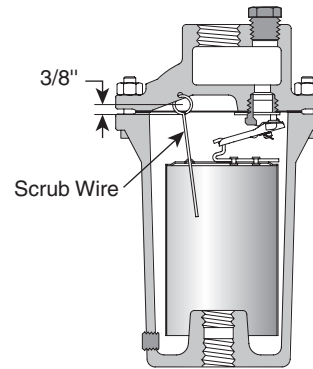

| Socketweld Dimensions | | | | | |
|-----------------------|----|-------|----|----------|----|
| Pipe Size | | S-2 | | S-4 Min. | |
| in | mm | in | mm | in | mm |
| 1/2 | 15 | 0.855 | 22 | 3/8 | 10 |
| 3/4 | 20 | 1.065 | 27 | 1/2 | 13 |
| 1 | 25 | 1.330 | 34 | 1/2 | 13 |
| 1-1/4 | 32 | 1.675 | 43 | 1/2 | 13 |
| 1-1/2 | 40 | 1.915 | 49 | 1/2 | 13 |
| 2 | 50 | 2.406 | 61 | 5/8 | 16 |
| 2-1/2 | 65 | 2.906 | 74 | 5/8 | 16 |
| 3 | 80 | 3.535 | 90 | 5/8 | 16 |

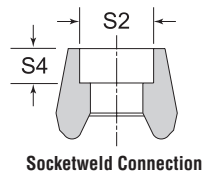

Flanged Connections

Flanged traps are furnished with the following ANSI B16.5 flanges as standard. Flange facings comply with ANSI B16.5.

| Pressure Class Rating | Inlet Connection | Outlet Connection |
|-----------------------|-------------------|-------------------|
| 150 and 300 | 1/16" Raised Face | 1/16" Raised Face |
| 600 and Higher | 1/4" Raised Face | 1/4" Raised Face |

Other types of flanged connections (such as large male and female ring joint, large or small tongue and groove, etc.) can be furnished. Flange requirements for both inlet and outlet must be specified.