

DIMENSIONS & DATA CERTIFIED FOR:

Representative:

Order:

Customer:

Order:

Project:

Requirements:

By:

Date:

DIMENSION	A	B
0" FILL HEAD	31	35
6" FILL HEAD	37	41
12" FILL HEAD	43	47
24" FILL HEAD	55	59

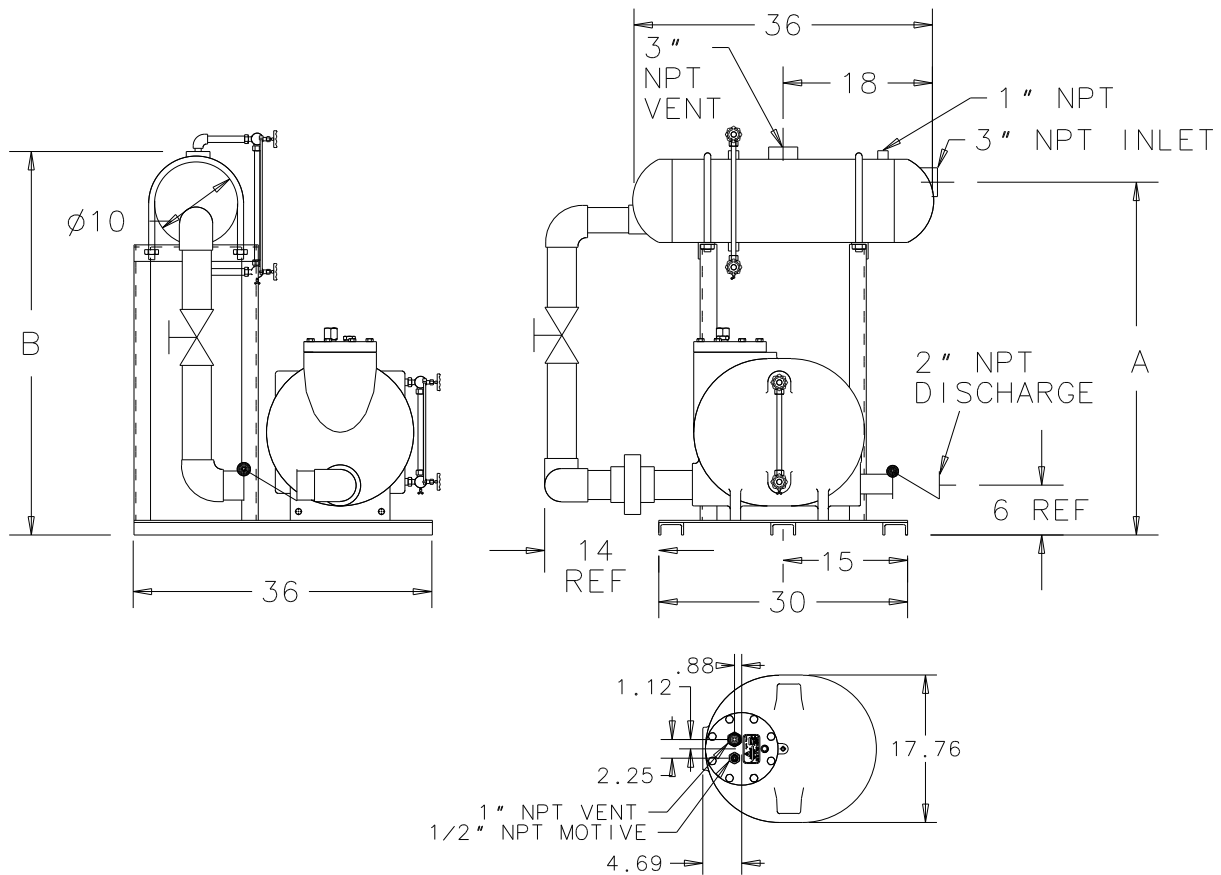

NOTES:

1. DRAWING SHOWS OPTIONAL GAUGE GLASSES.
2. RECEIVER ASME CODE 150 PSIG
3. RECEIVER VOLUME = APPROX. 10 GALLONS
4. SEE DRAWING CDF1038 FOR RECEIVER SIZING
5. FILL HEAD MUST BE SPECIFIED



Armstrong Condensate Management Group
Three Rivers, MI. 49093
Telephone (269) 279-3601
Fax (269) 279-3150
Posted on www.armstronginternational.com

Product	CDF No.	Date
SPT-3500LBRP-10	CDF 1085	06/21/06
		Rev. A