

DIMENSIONS & DATA CERTIFIED FOR:

Representative:

Order:

Customer:

Order:

Project:

Requirements:

By:

Date:

DIMENSION	A	B
0" FILL HEAD	39	54
6" FILL HEAD	45	60
12" FILL HEAD	51	66

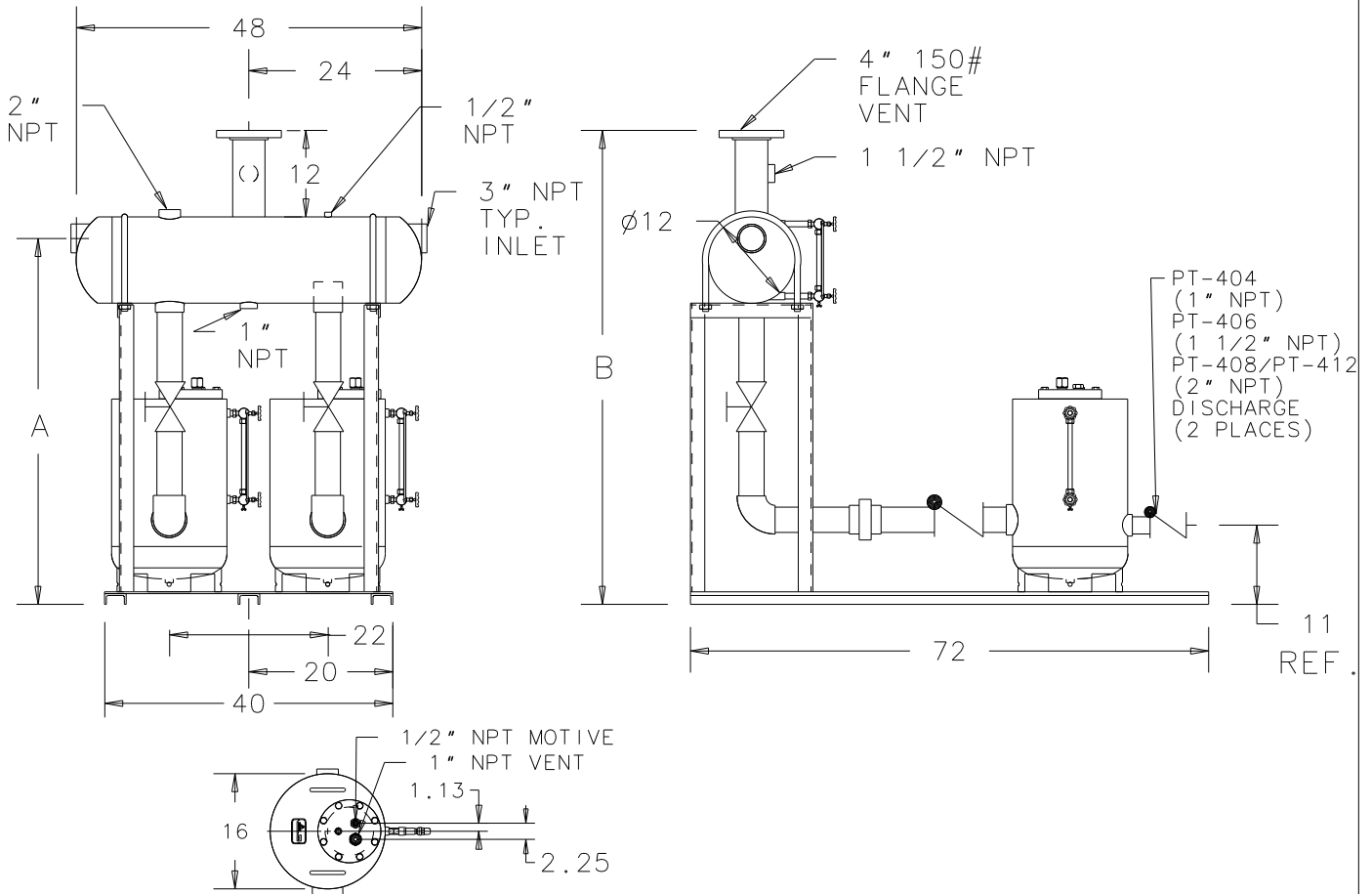

NOTES:

1. DRAWING SHOWS OPTIONAL GAUGE GLASSES.
2. RECEIVER ASME CODE 150 PSIG
3. RECEIVER VOLUME: APPROX. 22 GALLONS
4. FILL HEAD MUST BE SPECIFIED



Armstrong Condensate Management Group
 Three Rivers, MI. 49093
 Telephone (269) 279-3601
 Fax (269) 279-3150
 Posted on www.armstronginternational.com

Product	CDF No.	Date
DPT-400LBRP-12	CDF 1079	06/21/06
		Rev. A